

# DATASHEET

## HALF MASK

PROTECTION AGAINST GAS, VAPOUR & DUST



### SERIES 7000

**Size S**

 **7001**  
**7004 Silicone**

**Size M**

 **7002**  
**7005 Silicone**

**Size L**

 **7003**  
**7006 Silicone**

#### CHARACTERISTICS



**Extremely Lightweight**



**Easy to clean. Easy maintenance.**  
Easily accessible components. Clear design and surfaces.



**EasyLock® filter system**  
No additional parts needed.



**100% PVC-FREE**  
All Moldex products and packaging are 100% PVC-free.

#### EASYLOCK®

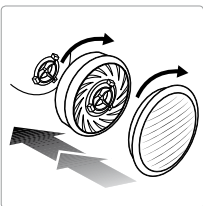
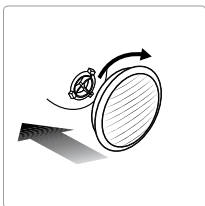
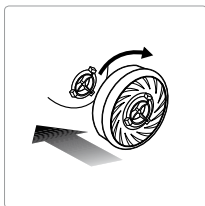

Gas filters		Particulate filters		Pre-assembled filter combinations	
Article	Type of filter	Article	Type of filter	Article	Type of filter
9100	A1	9010	P1 R	9120	ATP2 R
9200	A2	9020	P2 R	9230	A2P3 R
9300	ABE1	9030	P3 R	9430	ABEK1P3 R
9400	ABEK1	9022	P2 R + O <sub>3</sub>	9730	ABEK1HgP3 R D
9500	A2B2E1	9032	P3 R + O <sub>3</sub>		
9600	AX				
9800	ABEK2*				

\*EN 14387 weight limitation: ABEK2 + P2 or P3 restricted to full face mask.

#### CERTIFICATION

The Moldex Series 7000 meet the requirements of EN140:1998 and are CE-marked in accordance with the requirements of European Directive 89/686/EEC. The Institut für Arbeitsschutz IFA in St. Augustin (0121) in Germany is the body responsible for both type examination (article 10) and monitoring of production (article 11B). The products are manufactured in an ISO 9001 certified plant.

#### MATERIAL

**Face piece 7001/7002/7003:** Thermoplastic Elastomere (TPE)  
**Face piece 7004/7005/7006:** Silicone rubber  
**Head Strap:** Polypropylene (PP) + Lycra  
**Clip:** Polypropylene (PP)  
**Inhalation valve:** Natural rubber  
**Exhalation valve:** Silicone rubber

#### WEIGHT

**7001:** 98 g    **7002:** 98 g    **7003:** 100 g  
**7004:** 124 g    **7005:** 126 g    **7006:** 133 g

#### TESTING

The respirators of the Moldex 7000 Series have been tested to EN 140:1998 and fulfil all requirements of the relevant categories of the norm.

#### Inward leakage of face piece

Ten test subjects wearing respirators perform a variety of exercises on a treadmill. During the exercises the amount of aerosol that penetrates the filter, the face seal and the valve are sampled. The inward leakage of the test contaminant must not exceed a value of 5% of the inhaled air with 46 out of 50 test exercises. 8 out of 10 average values must not exceed 2% of the total inward leakage.

#### Flammability

The face piece is passed through a 800°C (+/- 50°C) flame with a speed of 6 cm/s. After passing through the flame the face piece has to self-extinguish.

# DATASHEET

## HALF MASK

PROTECTION AGAINST GAS, VAPOUR & DUST



### IMPORTANT INFORMATION FOR USERS

- This breathing apparatus does not supply oxygen (O<sub>2</sub>)
- The product does not contain any metallic parts that could cause ignition in potentially explosive atmospheres.
- If you have any questions about how to use the product, please contact MOLDEX-METRIC.
- You must also observe the relevant rules and regulations when using respiratory equipment.
- Under certain circumstances, individuals with beards, long sideburns or other anomalies in the area around the sealing lines, may be unable to achieve a properly sealing fit.
- The masks must not be modified in anyway.
- Read the instruction manual before using the mask. Failure to comply with these instructions on how to use the product and failure to wear the respiratory protection in the polluted area may negatively impact on the health of the user and lead to permanent injury.
- **Caution: Do not use filter equipment in unventilated containers and confined spaces.**

### SPARE PARTS

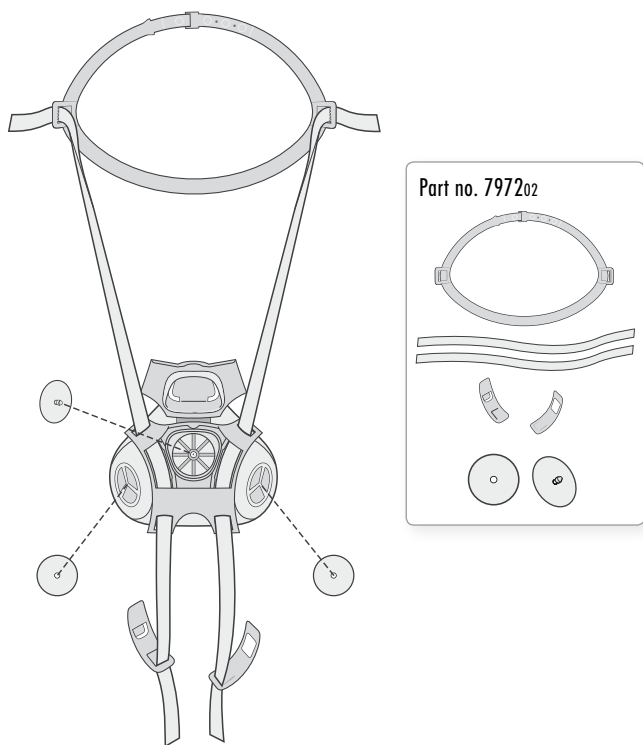

Part no.	Description
797202	Head Harness + Diaphragm kit

### INSTRUCTIONS FOR FITTING

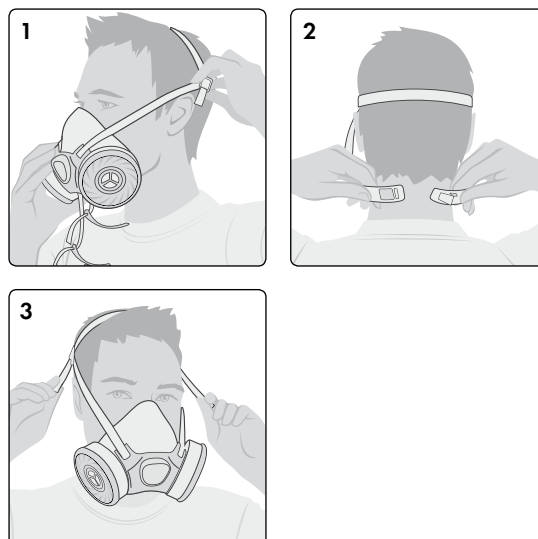

### CHECK OF FACESEAL

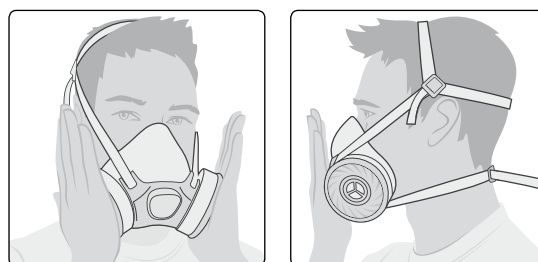

### LOCK MODE / DROP DOWN MODE

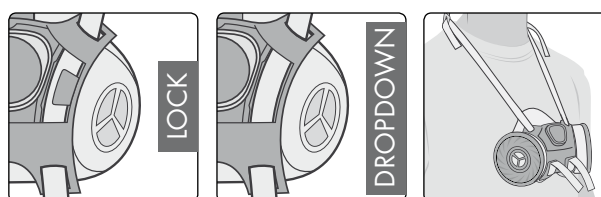

### INFO

For help on selection and training please contact us.  
We offer a wide range of training packages and support material.

MOLDEX-METRIC AG & Co. KG  
Unit 9, Glaisdale Point  
Off Glaisdale Drive, Bilborough  
Nottingham. NG8 4GP

Tel.: +44 (0)115 985 4288  
Fax: +44 (0)115 985 4211  
info@uk.moldex-europe.com  
www.moldex-europe.com